

Operating Instructions

Bench platform Puro®



Foreword

Must be followed!

Any information in this document is subject to change without notice and does not represent a commitment on the part of Minebea Intec unless legally prescribed. This product should only be operated/installed by trained and qualified personnel. In correspondence concerning this product, the type, name, and release number/serial number as well as all license numbers relating to the product have to be cited.

Note

This document is partially protected by copyright. It may not be changed or copied, and it may not be used without purchasing or written permission from the copyright owner (Minebea Intec). The use of this product constitutes acceptance by you of the abovementioned provisions.

Table of contents

1	Introduction	2
1.1	Read the manual	2
1.2	This is what operating instructions look like	2
1.3	This is what lists look like	2
1.4	This is what menu items and softkeys look like	2
1.5	This is what the safety instructions look like	2
2	Safety instructions	4
2.1	General information	4
2.2	Incoming goods inspection	4
2.3	Before operational startup	4
2.3.1	Danger of explosion	4
2.3.2	IP protection	5
2.3.3	Storage and transport conditions	5
2.4	Failure and excessive stress	5
3	Device installation	6
3.1	Mechanical preparation	6
3.1.1	Ambient conditions	6
3.1.2	Installation location	6
3.1.3	Unpacking	6
3.1.4	Checking the equipment supplied	6
3.1.5	Leveling the weighing platform	6
3.2	Connecting	7
3.2.1	Connecting the platform	7
4	Maintenance/repairs/cleaning	9
4.1	Repairs	9
4.2	Cleaning	9
4.2.1	Instructions for cleaning	9
4.2.2	Cleaning agents	9
5	Waste disposal policy	10
6	Technical data	11
6.1	Specification	11
6.2	Accessories	12
6.3	Dimensions	12

1 Introduction

1.1 Read the manual

- Please read this manual carefully and completely before using the product.
- This manual is part of the product. Keep it in a safe and easily accessible location.

1.2 This is what operating instructions look like

1. - n. are placed before steps that must be done in sequence.
 - ▶ is placed before a step.
 - ▷ describes the result of a step.

1.3 This is what lists look like

- indicates an item in a list.

1.4 This is what menu items and softkeys look like

[] frame menu items and softkeys.

Example:

[Start]- [Applications]- [Excel]

1.5 This is what the safety instructions look like

Signal words indicate the severity of the danger involved when measures for preventing hazards are not followed.

DANGER

Warning of personal injury

DANGER indicates death or severe, irreversible personal injury which will occur if the corresponding safety measures are not observed.

- ▶ Take the corresponding safety precautions.

WARNING

Warning of hazardous area and/or personal injury

WARNING indicates that death or severe, irreversible injury may occur if appropriate safety measures are not observed.

- ▶ Take the corresponding safety precautions.

CAUTION

Warning of personal injury.

CAUTION indicates that minor, reversible injury may occur if appropriate safety measures are not observed.

- ▶ Take the corresponding safety precautions.

NOTICE**Warning of damage to property and/or the environment.**

NOTICE indicates that damage to property and/or the environment may occur if appropriate safety measures are not observed.

- ▶ Take the corresponding safety precautions.
-

Note:

User tips, useful information, and notes.

2 Safety instructions

2.1 General information

NOTICE

Warning of damage to property and/or the environment.

The product complies with the directives and standards on electrical equipment, electromagnetic compatibility, and the prescribed safety requirements. However, improper use can cause damage to persons and property.

The product was in perfect condition with regard to safety features when it left the factory.

► To maintain this condition and to ensure safe operation, the user must follow the instructions and observe the warnings in this manual.

- The device may only be used as intended for weighing tasks.
- Observe the operating limits of the device.
- Do not apply loads that exceed the capacity of the scale.
- Before connecting or disconnecting electronic peripheral devices, disconnect the device from the mains or from the data interface.
- Unplug the power cord from the mains supply before cleaning.
- Make sure that no liquid enters the device.
- Do not lift the scale using the load plate. Always lift the scale using the platform.

2.2 Incoming goods inspection

Check the contents of the consignment for completeness. Check the contents visually to determine whether any damage has occurred during transport. If there are grounds for rejection of the goods, a claim must be filed with the carrier immediately. A Minebea Intec sales or service organization must also be notified. Visit our website <http://www.puroscales.com> or contact your dealer.

2.3 Before operational startup

NOTICE

Perform visual inspection.

Before operational startup as well as after storage or transport, inspect the product visually for signs of mechanical damage.

► The product should not be put into operation if it displays signs of visible damage and/or is defective.

2.3.1 Danger of explosion

Do not use the device in hazardous areas.

2.3.2 IP protection

The load cells fulfill protection grade IP67.

2.3.3 Storage and transport conditions

NOTICE

Material damage is possible.

Unpacked devices may lose their precision due to strong vibrations; strong vibrations may impair the safety of the device.

- ▶ Do not subject the device to extreme temperatures, moisture, shocks, and vibrations.
-

2.4 Failure and excessive stress

If the device or the power cord display visible damage: Disconnect the power supply and secure the device to prevent it being used further.

Do not unnecessarily subject the device to extreme temperatures, corrosive chemical vapors, moisture, shocks, and vibrations.

Extreme electromagnetic influences can affect the display value. Once the disturbance has ceased, the product can be used again as intended.

3 Device installation

3.1 Mechanical preparation

3.1.1 Ambient conditions

- Only use within buildings.
- Operating temperature range: -10°C to +40°C
- Storage temperature: -30°C to +70°C
- Relative humidity: 20% to 85%, non-condensing
- Altitude: up to 3,575 m

3.1.2 Installation location

- Place the device on a stable, flat, and horizontal surface.
- Set up the device so that the load cell cable does not present an obstacle or a trip hazard.

Avoid unsuitable influences at the installation location:

- Extreme temperatures and excessive temperature fluctuations
- Heat due to proximity to heaters or due to direct sunlight
- Aggressive chemical vapors
- Extreme moisture
- Extreme vibrations

3.1.2.1 Shock resistance

NOTICE

Falling objects, side impacts, and shock loads may affect the performance and the accuracy of the scale and damage the platform.

- ▶ Avoid shock loads.

3.1.3 Unpacking

- ▶ Unpack the device and check it for visible external damage.
 - ▷ If there is damage, follow the instructions in the chapter "Safety check".
- ▶ Keep the original packaging in case the device needs to be returned. Remove all cables before sending.

3.1.4 Checking the equipment supplied

- 1 bench platform
- Safety instructions and QR code for access to the complete documentation

3.1.5 Leveling the weighing platform

To achieve reproducible weighing results at all times, the weighing platform must be set up to be precisely horizontal.

Therefore the weighing platform must be re-leveled every time it is moved to a different location.

Leveling the weighing platform

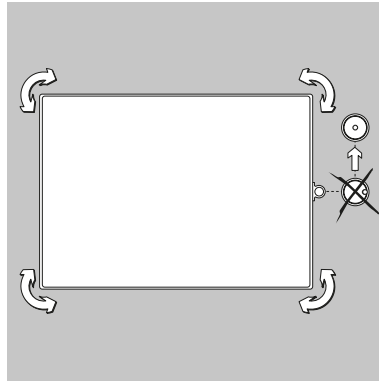

- ▶ Use the adjustable feet to align the weighing platform so that the air bubble of the level indicator is in the center of the circle.
- ▶ Check that all four of the adjustable feet are touching the surface.
 - ▷ The weight of the platform must be spread equally across the adjustable feet.
- ▶ Adjust the adjustable feet: Retract the adjustable feet (clockwise) in order to lift the scale. Extend the adjustable feet (counter-clockwise) in order to lower the scale.

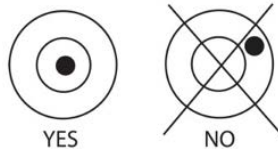

3.2 Connecting

3.2.1 Connecting the platform

Connection of an analogue Puro® platform or a commercially available strain gauge load cell to a Puro® indicator.

1. Switch off the indicator and disconnect from the electrical supply.
2. Turn over the indicator.
3. Remove the four rubber plugs on the back.
4. Loosen the screws underneath.
5. Remove the cover.
6. Loosen the screw connection.
7. Run the load cell cable through the screw connection.
8. Secure the wires of the load cell cable into the terminals; when doing so, pay attention to the pin assignments and the color coding of the connection cable for the platform/load cell.

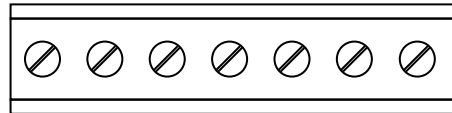
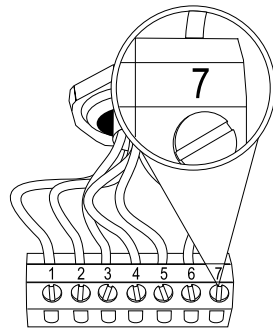

DGND S- S+ V- EX- EX+ V+

1	DGND	Ground
2	S-	Signal-
3	S+	Signal+
4	V-	Sense-
5	EX-	Supply voltage-
6	EX+	Supply voltage+
7	V+	Sense+

9. Tighten the screw connection.
10. Reassemble the housing, tighten the screws, and apply the rubber plugs.

3.2.1.1 Color coding

Wiring of the load cell cable

Model number	EX+	EX-	S+	S-	V+	V-	SCREEN
EF-DDP30-6d	red	black	green	white	n.a.	n.a.	blank
EF-DDP60-6d	red	black	green	white	n.a.	n.a.	blank
EF-FEP60-6d	red	black	green	white	blue	yellow	blank
EF-FEP150-6d	red	black	green	white	blue	yellow	blank
EF-GFP150-6d	red	black	green	white	blue	yellow	blank
EF-GFP300-6d	red	black	green	white	blue	yellow	blank
EF-DDS30-6d	green	black	white	red	blue	yellow	blank
EF-DDS60-6d	green	black	white	red	blue	yellow	blank
EF-FES60-6d	red	black	green	white	n.a.	n.a.	blank
EF-FES150-6d	red	black	green	white	n.a.	n.a.	blank
EF-GFS150-6d	red	black	green	white	n.a.	n.a.	blank
EF-GFS300-6d	red	black	green	white	n.a.	n.a.	blank

4 Maintenance/repairs/cleaning

4.1 Repairs

Disconnect a defective device from the mains immediately.

Defective or damaged cables or screw connections must be replaced as a complete unit.

⚠ WARNING

Improper repairs can pose considerable risks to the user.

- ▶ Only have repairs carried out by Minebea Intec qualified dealers using original spare parts.

4.2 Cleaning

4.2.1 Instructions for cleaning

⚠ WARNING

Working on a device that is switched on can have life-threatening consequences.

- ▶ Disconnect the device from the power supply before cleaning (disconnect the power plug from the electrical outlet).

The device must be cleaned of contaminants on a regular basis.

If the scale is in a dry environment, wipe the weighing platform with a damp cloth.

Household cleaning agents can be used. Please check the information provided by the manufacturer.

Devices with protection grade IP65 or above may also be rinsed with a water jet directed onto the load plate from above.

If the device is cleaned with water that is too hot or too cold due to temperature differences, condensation may form in the device. Condensation may cause malfunctions in the device.

4.2.2 Cleaning agents

NOTICE

Some cleaning agents may not be compatible with the device material.

- ▶ Only use disinfectants and cleaning agents in line with the manufacturer's instructions.
- ▶ Do not use cleaning agents that are very acidic, very alkaline, or that contain a high level of chlorine. Avoid substances with a high or low pH value as otherwise there is an increased risk of corrosion.
- ▶ Do not use any abrasive sponges containing iron, steel brushes, or cleaning sponges made of steel wool.
- ▶ Always test cleaning agents and materials in non-critical areas first before using them.

5 Waste disposal policy

If the packaging is no longer required, please take it to your local waste disposal facility and/or a reputable disposal company or collection point. The packaging largely consists of environmentally friendly materials, which are suitable for recycling.

It is not permitted—even for small businesses—to dispose of this product with the regular household waste or at collection points run by local public waste disposal companies.

EU legislation requires its Member States to collect electrical and electronic equipment and dispose of it separately from other unsorted municipal waste so that it can then be recycled.

Before disposing of or scrapping the product, any batteries should be removed and taken to a suitable collection point.

Please see our T&Cs for further information.

We reserve the right not to accept products that have been contaminated with hazardous substances (ABC contamination) for repair.

6 Technical data

6.1 Specification

Model number	EF-	30	60	150	300
Max load (g)		30,000	60,000	150,000	300,000
Readability d (g)		5	10	20	50
Max. resolution		6,000	6,000	7,500	6,000
Repeatability error		1 d	1 d	1 d	1 d
Linearity		±1 d	±1 d	±1 d	±1 d
Dimensions in mm (W x D x H)	DD	355 x 305 x 123	355 x 305 x 123	-	-
	FE	-	550 x 420 x 136	550 x 420 x 136	-
	GF	-	-	650 x 500 x 143	650 x 500 x 143
Version/materials platform	P	Frame made of painted carbon steel, load plate made of stainless steel 304, 1.2 mm			
	S	Entirely made of stainless steel 304			
Safe overload range		150% of the max. load of the scale			
"Ultimate" overload range		300% of the max. load of the scale			
Corner load overload resistance		100% of the max. load of the scale			
Leveling aids		Externally visible level indicator and adjustable, non-slip leveling feet			
Feet		4 adjustable, non-slip leveling feet			
Operating temperature (°C)		-10...40			
Storage temperature (°C)		-30...70			
Protection grade of the load cell(s)		IP67			
Supply voltage of the load cell(s)		max. 18 V (AC/DC)/5 V–12 V (AC/DC) recommended			
Net weight (kg)	DD	7.5	7.5	-	-
	FE	-	16.65	16.65	-
	GF	-	-	20.6	20.6
Shipping dimensions in mm (W x D x H)	DD P/S	400 x 360 x 140	400 x 360 x 140	-	-
	FE	-	600 x 480 x 165	600 x 480 x 165	-

Model number	EF-	30	60	150	300	
	GF	-	-	700 x 560 x 165	700 x 560 x 165	
Shipping weight (kg)	DD	P	15	15	-	-
		S	18	18	-	-
	FE	P	-	23	23	-
		S	-	26	26	-
	GF	P	-	-	37	37
		S	-	-	38	38

6.2 Accessories

Option	Order no.
Stand for table, stainless steel Height 300 mm: 355 x 305 mm	YP-CBS1
Stand for table, stainless steel Height 600 mm: 550 x 420 mm	YP-CBS2

6.3 Dimensions

EF-DDP-.../EF-DDS-...

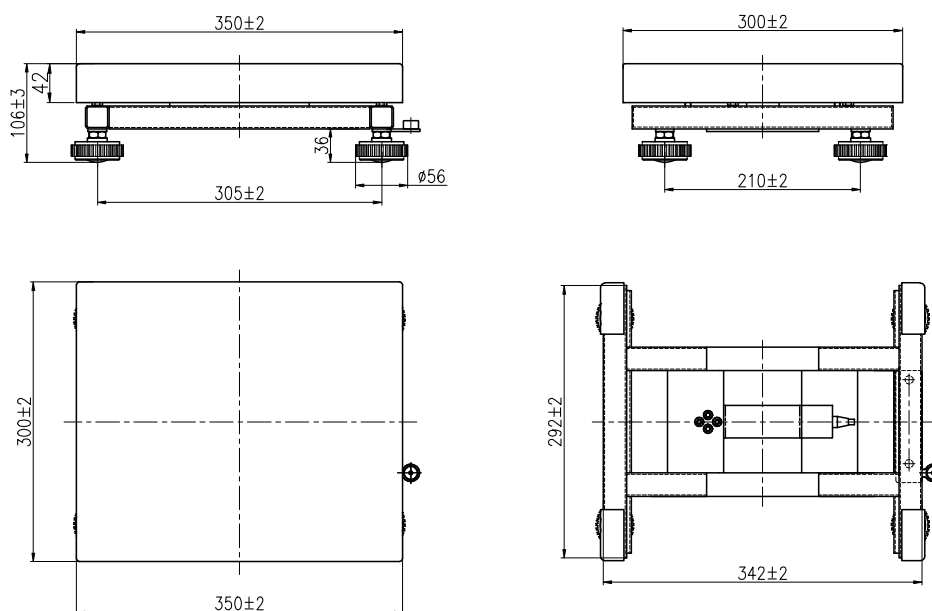

All dimensions in mm

EF-FEP-.../EF-FES-...

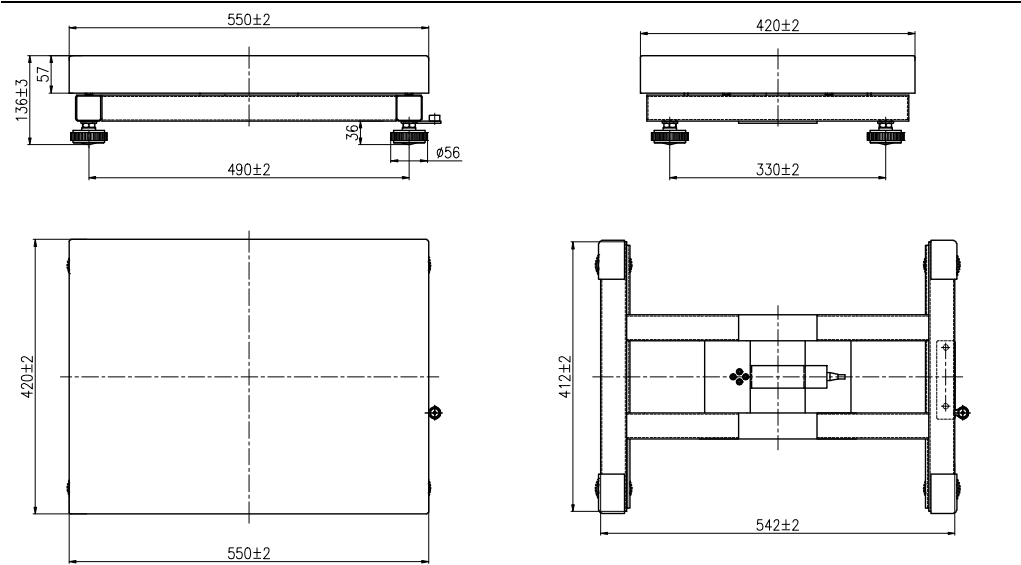

All dimensions in mm

EF-GFP-.../EF-GFS-...

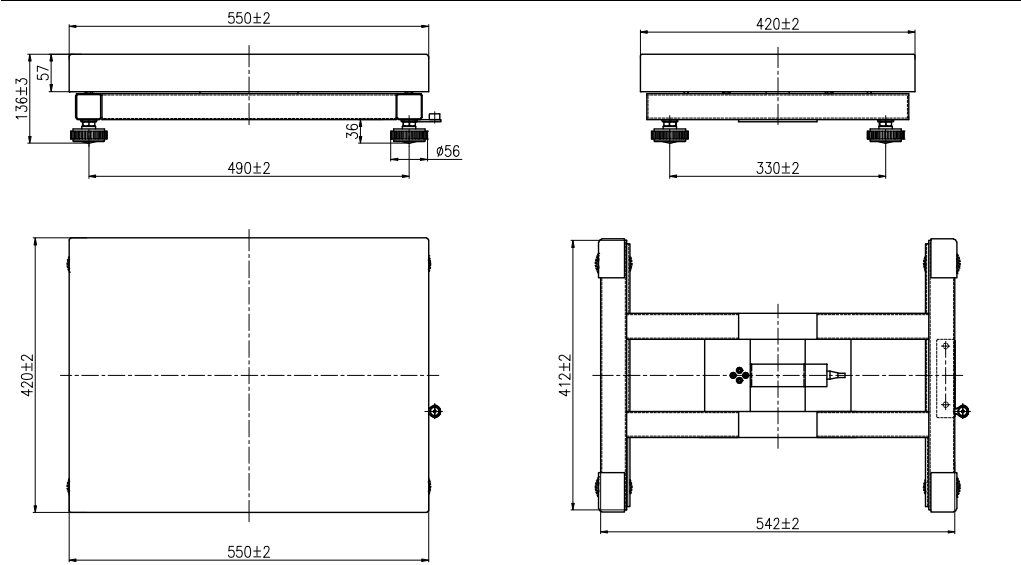

All dimensions in mm

Published by
Minebea Intec Bovenden GmbH & Co. KG | Leinetal 2 | 37120 Bovenden, Germany
Phone: +49.551.309.83.0 | Email: info@minebea-intec.com
www.minebea-intec.com

